

# User's Manual



Quartz Supreme  
Postbake Oven  
85/125



# User's Manual

---

## Quartz Supreme Postbake Oven 85/125

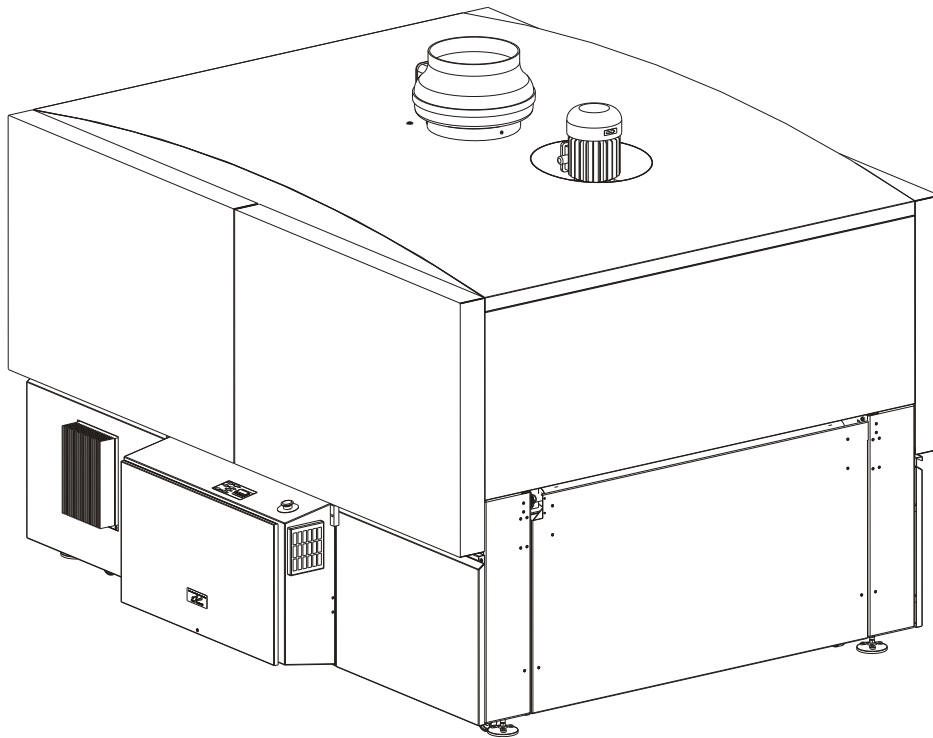

© 2007 Glunz & Jensen A/S. All rights reserved.

**User's Manual - Quartz Supreme Postbake Ovens 85/125**

**Part no. 51560, rev. AA - April 2007**

The information in this manual is furnished for informational use only, is subject to change without notice, and should not be construed as a commitment by Glunz & Jensen A/S.

Glunz & Jensen A/S assumes no responsibility or liability for any errors or inaccuracies that may appear in this manual.

Glunz & Jensen A/S assumes no responsibility or liability for loss or damage incurred during or as a result of using Glunz & Jensen products.

Printed in Denmark.

# Table of Contents

<b>Part 1: Introduction</b> .....	1-1
About this manual .....	1-1
Intended use of this manual .....	1-1
Illustrations .....	1-1
Reservations .....	1-1
Important! .....	1-1
Approvals: .....	1-1
Intended use of the equipment: .....	<b>1-1</b>
Installation: .....	1-2
Technical Data: .....	1-2
Notes, Cautions and Warnings! .....	1-2
Explanation .....	1-2
Functional Description .....	1-3
General .....	1-3
<b>Part 2: Operating Procedures</b> .....	2-1
Oven control panel .....	2-1
Shutdown procedure .....	2-1
Turning the Postbake Oven to “sleep mode” .....	2-1
Complete shutdown .....	2-2
Temperature adjustment .....	2-2
Transport conveyor speed adjustment .....	2-3
<b>Part 3: Cleaning and Maintenance</b> .....	3-1
General .....	3-1
Cleaning .....	3-1
Daily .....	3-1



# Part 1: Introduction

## About this manual

### Intended use of this manual

- This manual is for the daily user of the equipment. Always read the Safety Instruction Manual, part No 21741 before starting up the equipment and keep it with the machine for reference at all times.

### Illustrations

- As this manual covers a complete range of ovens the illustrations may not fully reflect your present oven.

### Reservations

- This manual was written and illustrated using the best possible information available at the time of publication.
- Any differences between this manual and the equipment reflect improvements introduced after the publication of the manual.
- Changes, technical inaccuracies and typographical errors will be corrected in subsequent editions.
- As a part of our policy of continuous improvement, we reserve the right to alter design and specifications without prior notice.

## Important!

### Approvals:

- The oven is manufactured according to legal demands. For compliance with the requirements the equipment is tested by Underwriters Laboratories or other accredited authority. Approvals will appear on the labels attached to the equipment's name plate located on the base frame of the oven.

### Intended use of the equipment:

- Development of photographic materials as specified in "Technical specifications" in Section 1 of the Service Manual.

**Installation:**

- It is the responsibility of the owner and operator/s of this oven, that the installation is made in accordance with local regulations, and by engineers authorized to carry out electrical installations.
- Installation, service and repair must be performed only by service technicians who are trained in servicing the equipment.
- The installation procedure is described in “Installation” in Section 2 of the Service Manual.
- The manufacturer cannot be held responsible for any damage caused by incorrect installation of this oven.

**Technical Data:**

- Observe technical data from the oven name plate located on the base of the oven

**Notes, Cautions and Warnings!**

Throughout the manual notes, cautions, and warnings are indicated with various icons and written in bold like the example below:



**Never use hard tools or abrasive materials when cleaning any part of the equipment.**

**Explanation**

**The operator should observe and/or act according to the information in order to obtain the best possible function of the equipment.**



**The operator must observe and/or act according to the information in order to avoid any mechanical or electrical damage to the equipment.**



**The operator must observe and/or act according to the information in order to avoid personal injury.**



## Functional Description

### General

The Quartz Supreme Postbake Oven is designed to deliver precise and uniform postbaking of thermal plates ensuring consistently high processing quality.





At one of four preselected conveyor speeds the plates are run through the oven. The balanced air flow ensures an exceptional heating uniformity across the plate within  $\pm 7.5^{\circ}\text{C}$ .

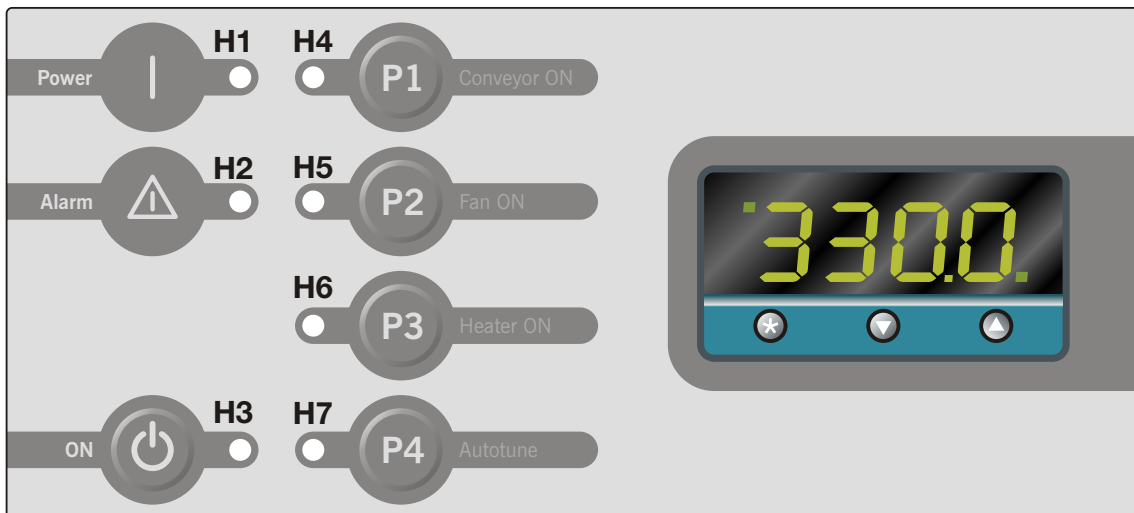

# Part 2: Operating Procedures

## Oven control panel



- 1 Turn on the power supply with the mains switch. The green LED (H1) will light.
- 2 Press the standby key .
- 3 The oven starts with the last active program. H2 is on until the set point has been reached. H4 or H5 or H6 or H7 is on.
- 4 Select the desired program by pressing one of the P-keys, , ,  or .

## Shutdown procedure

### Turning the Postbake Oven to “sleep mode”

- Press the standby key . LED H3 starts flashing to indicate the “off” cycle has started. When the oven has cooled down to <80 C, the unit will enter sleep mode.

## Complete shutdown

**i** The oven should only be shut down completely for holidays or for maintenance and servicing purposes.

- 1 Wait until the oven has gone into sleep mode (below 80 C).
- 2 Shut down the oven by switching the mains switch (located on the left-hand side of the Electrical Enclosure) to "OFF".

**!** The oven unit should only be switched off from the control panel. **DO NOT** turn off the fan or isolate the machine from the mains supply before the shutdown sequence is completed as damage may occur.

## Temperature adjustment

The oven is fitted with a temperature controller on the control panel, located on the Electrical Enclosure.



To adjust the plate surface temperature:

- 1 Press the button marked "★" and hold down. The unit will display the pre-set temperature.
- 2 To increase the plate temperature, press the button marked "▲" until the required temperature is indicated on the display.
- 3 To decrease the plate temperature, press the button marked "▼" until the required temperature is indicated on the display.
- 4 Release the button marked "★". The unit will then display the current oven temperature. Time should be allowed for the oven to reach the new oven setting (as indicated on the Control Unit) before processing the plates.

**i** When a plate enters the oven, the temperature indicated on the display will fall by approximately 2°C or 4°F, and will then recover to the pre-set temperature within a short time. This is normal and has no effect on the final plate temperature.

## Transport conveyor speed adjustment

This adjustment should be carried out by a service technician only.



# Part 3: Cleaning and Maintenance

## General

- 1 The Conveyor Belt Drive Chain should be lightly lubricated with SAE 20/50 Oil, and the tension checked and re-set if required every 6-12 months.
- 2 The Conveyor Belt Tension should be checked and re-set if required every 6-12 months.
- 3 All of the bearings are sealed and require no maintenance.

 The Oven is fitted with an over-temperature protection device that is factory set to prevent the temperature from rising above approximately 200°C. This unit will override a higher setting entered into the switch plate mounted temperature controller.

In the event that the temperature rises above this over-temperature setting, the heating system will automatically switch off, and an intermittent audible alarm will sound. This will indicate a fault with the heating or temperature control systems within the oven.

An electrical engineer should therefore examine the machine and rectify any fault before continuing. Note that the alarm will continue to sound until the temperature has fallen such that the heating system can again be turned on.

## Cleaning

 Cleaning components with anything other than a mild detergent or a recommended cleaning agent may cause irreversible damage and invalidate any warranty.

 Never use hard tools or abrasive materials when cleaning any part of the equipment.

 Always unplug the unit from the power outlet or the mains supply before carrying out any cleaning or maintenance procedures etc.

## Daily

Wipe the machine with a damp cloth to remove dust, pay particular attention to the input area of the machine.

 Never touch the top of the oven after it has been operated as the temperature exceeds 40°C.

